



# LabJaws Clamps & Supports



*Multi Purpose Clamps  
Specialty Clamps  
Connectors and Holders  
Rods, Frames, and Supports  
Flow Control Clamps  
Misc. Non-Electrical Products*



***Ingeniously Practical***

# Multi-Purpose Clamps



Our Multi-Purpose Clamps are designed to securely grip and position laboratory apparatus. Extension arms with a 360° rotation allow placement of apparatus at various distances from lab-frame without compromising experiment integrity. Swivel & fixed position clamps hold apparatus near the lab-frame or stand, and have a built-in integral holder for attaching to lab-frames or apparatus. Available as single or dual-adjust in zinc or stainless steel.

- Choice of Zinc or Stainless Steel to Best Suit Your Application
- 2 and 3-Prong Construction Allows for Securely Holding Glassware and Apparatus
- Greater Flexibility Over a Wider Range of Motion with Dual Prong Adjustment

## Multi-Purpose Clamps

### UltraJaws Heavy-Duty Clamps

- Large grip adjustment range
- Single or dual adjust
- Available in three sizes; small, medium, and large
- Nickel-plated zinc

Our patented multi-purpose UltraJaws Heavy-Duty Clamps feature an innovative closed yoke construction that minimizes contamination and corrosion of internal components. The unique design enables secure gripping and positioning with added strength and durability.

Available in both single and dual prong adjustment, prongs open gradually to maximize grip size without binding. Both designs feature precise pressure regulation when gripping glassware surfaces to reduce the chance of breakage. UltraJaws clamps are constructed with extension rods for easy attachment to lab-frames and other apparatus. Supplied with non-slip vinyl sleeves and, for temperatures above 100°C, fiberglass covers.

The prong height of the UltraJaws Heavy-Duty Clamps make them ideal for use in holding and securing glassware with precision ground glass joints. The chart details which UltraJaws Clamps are recommended.

**NOTE:** An additional holder must be purchased in order to attach clamps to frames or other apparatus.

See the Connectors & Holders section of this catalog, pages 92-95.

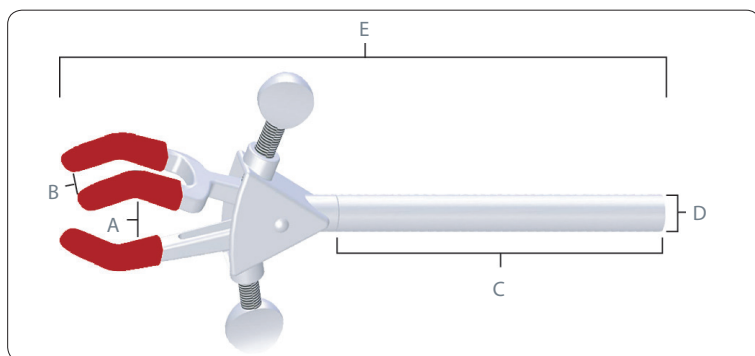

### Ground Glass Joint Reference Chart

Clamp	Joint Size
Small Dual Adjust	10/30, 12/30, 14/20, 19/22, 24/40, 29/42, 34/45
Medium Dual Adjust	14/40, 19/38
Large Dual Adjust	45/50

### 3-Prong Single Adjust Clamps

Size	(A) Min. to Max Grip Size	(B) Prong Width	(C) Arm Length	(D) Arm Dia.	(E) Overall Length	Item Number
Small	0 to 23 mm (0 to 0.91")	6 mm (0.24")	102 mm (4")	8 mm (0.32")	162 mm (6.38")	30392254
Medium	0 to 50 mm (0 to 1.97")	19 mm (0.75")	127 mm (5")	11 mm (0.43")	229 mm (9.02")	30392252
Large	0 to 72 mm (0 to 2.83")	29 mm (1.14")	127 mm (5")	11 mm (0.43")	260 mm (10.24")	30392250

### 3-Prong Dual Adjust Clamps

Size	(A) Min. to Max Grip Size	(B) Prong Width	(C) Arm Length	(D) Arm Dia.	(E) Overall Length	Item Number
Small	0 to 32 mm (0 to 1.26")	6 mm (0.24")	102 mm (4")	8 mm (0.32")	152 mm (5.98")	30392253
Medium	0 to 70 mm (0 to 2.76")	19 mm (0.75")	127 mm (5")	11 mm (0.43")	222 mm (8.74")	30392251
Large	0 to 103 mm (0 to 4.06")	29 mm (1.14")	127 mm (5")	11 mm (0.43")	260 mm (10.24")	30392249

### Single Adjust Clamps



### Dual Adjust Clamps





# LabJaws Clamps & Supports

## Multi-Purpose Clamps

### Heavy-Duty Tapered Clamps

Heavy-Duty, 4-prong, dual adjust tapered clamps are designed to hold large vessels with ground glass joint necks. Clamps are constructed with extension rods for easy attachment to lab-frames and other apparatus. Nickel-plated zinc construction.

**NOTE:** An additional holder must be purchased in order to attach clamps to frames or other apparatus.

See the Connectors & Holders section of this catalog, pages 92-95.

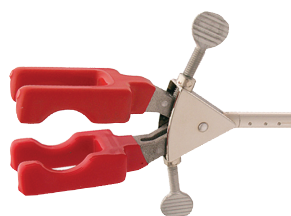

30392194

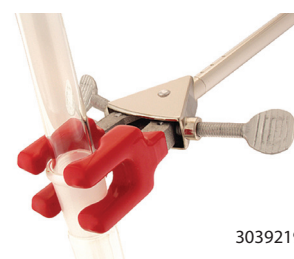

30392193

Size	Joint Size	Prong Width	Arm Length	Arm Dia.	Overall Length	Item Number
Small	24/40 mm	16 mm (0.63")	229 mm (9.02")	13 mm (0.51")	356 mm (14")	30392193
Large	34/45 mm	19 mm (0.75")	229 mm (9.02")	13 mm (0.51")	381 mm (15")	30392194

## Multi-Purpose Clamps

- Stainless steel, electro-polished finish
- Large dual adjustment range
- Available in three sizes; small, medium, and large

These durable, multi-purpose clamps are made entirely of stainless steel with an electro-polished finish and offer excellent chemical resistance and overall strength. The versatile 3-prong design secures various lab apparatus such as jointed glassware, columns, flasks, and tubes. Dual prong adjustments offer a wide range of motion. Long stainless steel extension arm offers easy positioning and depth adjustment. Autoclavable. Supplied with non-slip vinyl sleeves and, for temperatures above 100°C, fiberglass covers.

**NOTE:** An additional holder must be purchased in order to attach clamps to frames or other apparatus.

See the Connectors & Holders section of this catalog, pages 92-95.



30392352



30392353



30392354

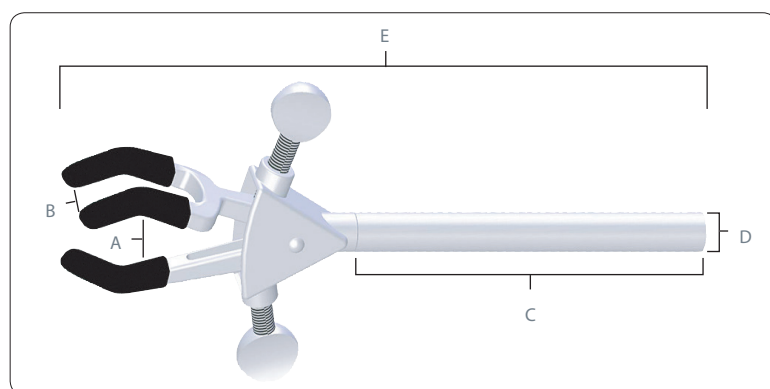

### 3-Prong Stainless Steel Dual Adjust Clamps

Size	(A) Min. to Max Grip Size	(B) Prong Width	(C) Arm Length	(D) Arm Dia.	(E) Overall Length	Item Number
Small	0 to 48 mm (0 to 1.9")	13 mm (0.51")	102 mm (4")	10 mm (0.39")	172 mm (6.77")	30392354
Medium	0 to 69 mm (0 to 2.72")	19 mm (0.75")	127 mm (5")	13 mm (0.51")	229 mm (9.02")	30392353
Large	0 to 102 mm (0 to 4")	29 mm (1.14")	127 mm (5")	13 mm (0.51")	273 mm (10.75")	30392352



## Multi-Purpose Clamps

### 3-Prong Multi-Purpose Clamps

- Large grip adjustment range
- 3-prong construction
- Single or dual adjust
- Nickel-plated zinc

Designed to securely hold every type of laboratory glassware and apparatus. Long, seamless nickel-plated brass tubing attaches clamp head securely and offers easy positioning in the deepest fume hoods. Clamps are constructed with round extension arms, which allow the clamps to be rotated 360°. Extension arms also allow placement of apparatus at various distances from lab-frames without compromising the integrity of your experiment. Supplied with non-slip vinyl sleeves and, for temperatures above 100°C, fiberglass covers.

**NOTE:** An additional holder must be purchased in order to attach clamps to frames or other apparatus.

See the Connectors & Holders section of this catalog, pages 92-95.

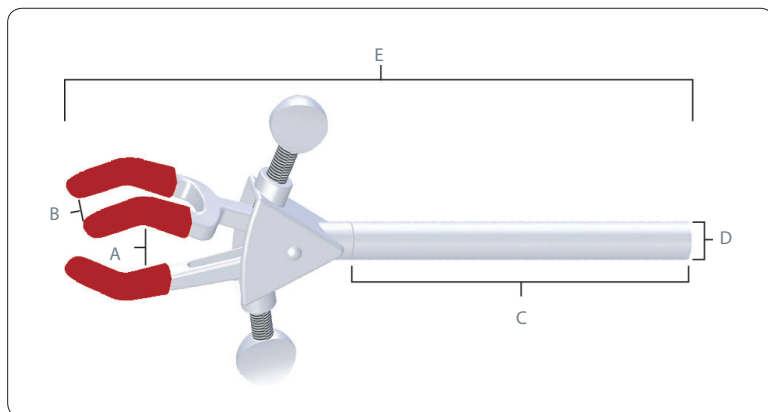

### 3-Prong Single Adjust Clamps



### 3-Prong Dual Adjust Clamps

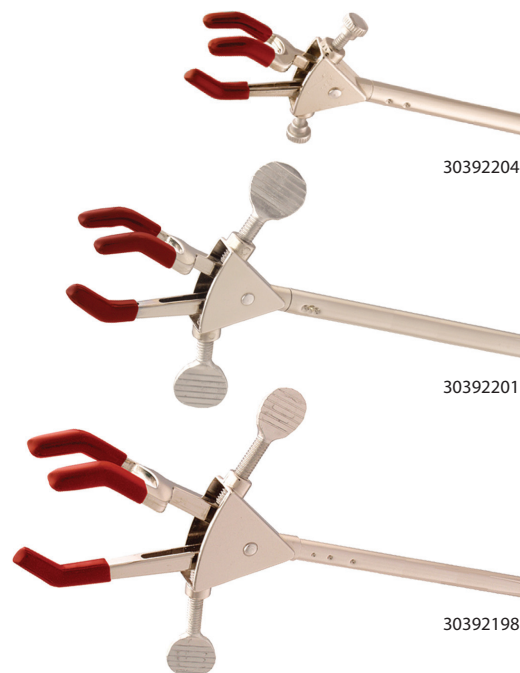

### 3-Prong Single Adjust Clamps

Size	(A) Min. to Max Grip Size	(B) Prong Width	(C) Arm Length	(D) Arm Dia.	(E) Overall Length	Item Number
Small	0 to 39 mm (0 to 1.54")	11 mm (0.43")	102 mm (4")	8 mm (0.32")	160 mm (6.3")	30392205
Medium	0 to 71 mm (0 to 2.8")	19 mm (0.75")	127 mm (5")	11 mm (0.43")	218 mm (8.58")	30392203
Large	0 to 108 mm (0 to 4.25")	29 mm (1.14")	127 mm (5")	11 mm (0.43")	248 mm (9.76")	30392200

### 3-Prong Dual Adjust Clamps

Size	(A) Min. to Max Grip Size	(B) Prong Width	(C) Arm Length	(D) Arm Dia.	(E) Overall Length	Item Number
Small	0 to 46 mm (0 to 1.81")	11 mm (0.43")	102 mm (4")	8 mm (0.32")	168 mm (6.61")	30392204
Medium	0 to 69 mm (0 to 2.72")	19 mm (0.75")	127 mm (5")	11 mm (0.43")	229 mm (9.02")	30392201
Medium (extended)	0 to 69 mm (0 to 2.72")	19 mm (0.75")	305 mm (12")	13 mm (0.5")	406 mm (16")	30392202
Large	0 to 105 mm (0 to 4.13")	29 mm (1.14")	127 mm (5")	11 mm (0.43")	273 mm (10.75")	30392198
Large (extended)	0 to 105 mm (0 to 4.13")	29 mm (1.14")	305 mm (12")	13 mm (0.5")	451 mm (17.76")	30392199

# LabJaws Clamps & Supports

## Multi-Purpose Clamps

### 2-Prong Multi-Purpose Clamps

- Stainless steel electro-polished finish or nickel-plated zinc
- Large grip adjustment range
- 2-prong construction
- Single or dual adjust

Designed to securely hold laboratory glassware and apparatus. Extension arm attaches clamp head securely and offers easy positioning in the deepest fume hoods. Clamps are constructed with round extension arms, which allow the clamps to be rotated 360°. Extension arms also allow placement of apparatus at various distances from lab-frames without compromising the integrity of your experiment. Stainless steel clamps are electro-polished and made entirely of stainless steel. They offer exceptional chemical resistance and are autoclavable. Nickel-plated zinc offers a clamp with a high tensile strength at an economical price. Supplied with non-slip vinyl sleeves and, for temperatures above 100°C, fiberglass covers.

**NOTE:** An additional holder must be purchased in order to attach clamps to frames or other apparatus.

See the Connectors & Holders section of this catalog, pages 92-95.

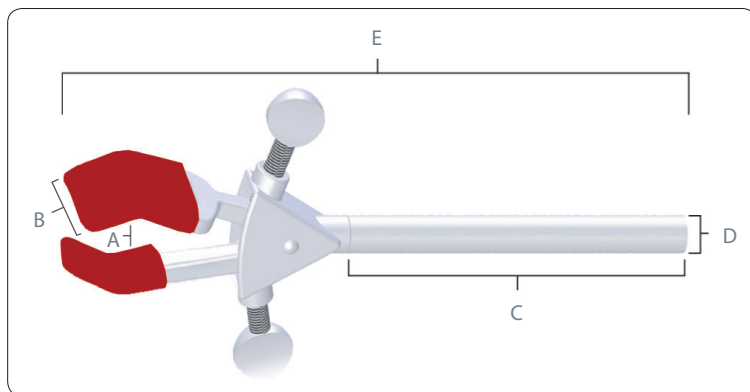

### 2-Prong Single Adjust Clamps



### 2-Prong Dual Adjust Clamps

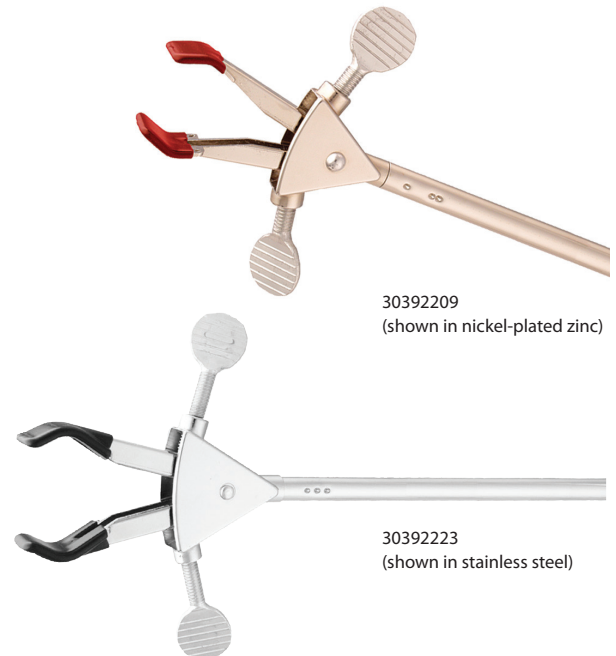

### 2-Prong Single Adjust Clamps

Material	Size	(A) Min. to Max Grip Size	(B) Prong Width	(C) Arm Length	(D) Arm Dia.	(E) Overall Length	Item Number
Nickel-plated zinc	Medium	0 to 78 mm (0 to 3.07")	23 mm (0.91")	127 mm (5")	11 mm (0.43")	216 mm (8.5")	30392208
Nickel-plated zinc	Large	0 to 92 mm (0 to 3.62")	23 mm (0.91")	127 mm (5")	11 mm (0.43")	229 mm (9.02")	30392206

### 2-Prong Dual Adjust Clamps

Material	Size	(A) Min. to Max Grip Size	(B) Prong Width	(C) Arm Length	(D) Arm Dia.	(E) Overall Length	Item Number
Stainless steel	Medium	0 to 75 mm (0 to 2.95")	23 mm (0.91")	127 mm (5")	11 mm (0.43")	229 mm (9.02")	30392220
Nickle-plated zinc	Medium	0 to 75 mm (0 to 2.95")	23 mm (0.91")	127 mm (5")	11 mm (0.43")	229 mm (9.02")	30392209
Stainless steel	Large	0 to 95 mm (0 to 3.74")	23 mm (0.91")	127 mm (5")	11 mm (0.43")	248 mm (9.76")	30392223
Nickle-plated zinc	Large	0 to 95 mm (0 to 3.74")	23 mm (0.91")	127 mm (5")	11 mm (0.43")	248 mm (9.76")	30392207

## Multi-Purpose Clamps

### Swivel Clamps

Used to hold apparatus near the lab-frame. Unlike extension clamps, the swivel clamps have an integral holder for attaching to a lab-frame or other apparatus. Built-in holder grips rods up to 19 mm (0.75") in diameter and is adjustable for forward or reverse-facing adjustment screws. Shaft wing-nut allows the holding angle of the swivel clamp to adjust through 360° of rotation and can be locked in place once desired position is achieved. Stainless steel electro-polished finish or nickel-plated zinc construction. Supplied with non-slip vinyl sleeves and, for temperatures above 100°C, fiberglass covers.



Material	Description	Size	Min. to Max. Grip Size	Prong Width	Overall Length	Item Number
Stainless steel	2-Prong Single Adjust	Medium	0 to 76 mm (0 to 3")	23 mm (0.91")	163 mm (6.42")	30392226
Nickel-plated zinc	2-Prong Single Adjust	Medium	0 to 76 mm (0 to 3")	23 mm (0.91")	163 mm (6.42")	30392215
Nickel-plated zinc	2-Prong Single Adjust	Large	0 to 95 mm (0 to 3.74")	23 mm (0.91")	180 mm (7.09")	30392216
Stainless steel	3-Prong Dual Adjust	Medium	0 to 69 mm (0 to 2.72")	20 mm (0.79")	178 mm (7.01")	30392225
Nickel-plated zinc	3-Prong Dual Adjust	Medium	0 to 69 mm (0 to 2.72")	20 mm (0.79")	178 mm (7.01")	30392214

### Fixed-Position Clamps

Used to hold apparatus near the lab-frame where no adjustment is required after set-up. Built-in holder grips rods up to 19 mm (0.75") in diameter Fixed-Position Clamps have an integral holder but can be rotated after attachment to a lab-frame or other apparatus. Available in 2-prong or 3-prong. Stainless steel electro-polished finish or nickel-plated zinc construction. Supplied with non-slip vinyl sleeves and, for temperatures above 100°C, fiberglass covers.

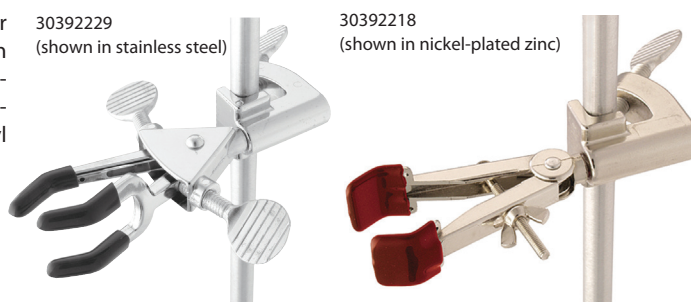

Material	Description	Size	Min. to Max. Grip Size	Prong Width	Overall Length	Item Number
Stainless steel	2-Prong Single Adjust	Medium	0 to 77 mm (0 to 3.03")	23 mm (0.91")	133 mm (5.24")	30392230
Nickel-plated zinc	2-Prong Single Adjust	Medium	0 to 77 mm (0 to 3.03")	23 mm (0.91")	133 mm (5.24")	30392218
Stainless steel	3-Prong Dual Adjust	Medium	0 to 69 mm (0 to 2.72")	20 mm (0.79")	146 mm (5.75")	30392229
Nickel-plated zinc	3-Prong Dual Adjust	Medium	0 to 69 mm (0 to 2.72")	20 mm (0.79")	146 mm (5.75")	30392217



# Specialty Clamps



LabJaws Specialty Clamps hold large, cylindrical or irregular-shaped glassware to lab-frames and rods, sturdily yet gently. Designed to accommodate vessels of varying diameters, and with extension arms that allow 360° rotation, these clamps offer flexibility for lab use. Choose from a range of specialty clamps—including chain clamps, double buret holders & column clamps to suit your application. Available in stainless steel, zinc and aluminum.

- Choose the Material That Best Suits Your Application
- Chain Clamps Offer Quick & Secure Slip-On Chain Connection With Adjustable Knob
- Double Buret Clamps Securely Hold Burets from Micro to 100 mL Capacity

## Specialty Clamps

### Thermometer Swivel Clamp

Holds glass tubes and thermometers 114 mm (4.49") from support rod. Clamp features safety adjust spring plate jaws that adjust to any angle with locking wing-nut. Built-in holder grips rods up to 19 mm (0.75") in diameter. Lightweight, rust, and corrosion-resistant. Nickel-plated construction.

Min. to Max. Grip Size	Overall Length	Item Number
6 to 8 mm (0.24 to 0.32")	159 mm (6.26")	30392238



### Thermometer / Thermocouple Extension Clamp

Lightweight clamp holds glass tubing, thermometers or thermocouples up to 178 mm (7") from support rod. Tightening wing-nut applies tension to the nickel-plated jaws.

NOTE: An additional holder must be purchased in order to attach clamps to frames or other apparatus.

See the Connectors & Holders section of this catalog, pages 92-95.

Min. to Max. Grip Size	Ext Arm Length	Arm Dia.	Overall Length	Item Number
6 to 12 mm (0.24 to 0.47")	127 mm (5")	11 mm (0.43")	210 mm (8.27")	30392239

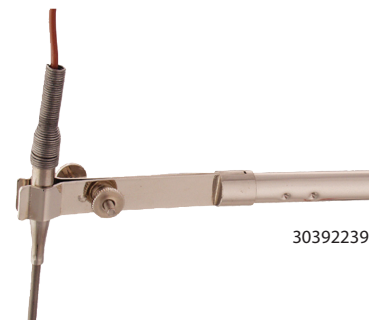

### Wall Clamp

Ideal for securing fermentation tubes, burets or other small objects to walls where no frames are available. Integral self-tapping screw secures clamp to wall. Nickel-plated construction.

Min. to Max. Grip Size	Overall Length	Item Number
5 to 10 mm (0.2 to 0.39")	80 mm (3.15")	30392244

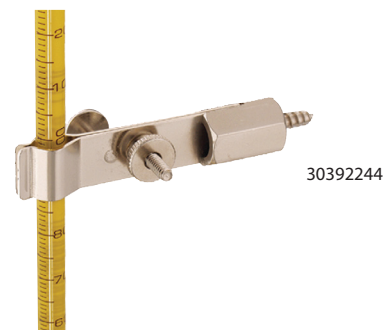

### Water Bath Clamps

Holds a variety of apparatus, including glass tubes and thermometers onto glass water bath walls. Built-in holder grips walls of varying thickness, up to 9 mm (0.35"). Knurled thumbscrew tightens jaws to hold objects firmly. Nickel-plated zinc construction. Large water bath clamp is supplied with non-slip vinyl sleeves and, for temperatures above 100°C, fiberglass covers.

Size	Min. to Max. Grip Size	Prong Width	Overall Length	Item Number
Small	5 to 10 mm (0.2 to 0.39")	N/A	89 mm (3.5")	30392240
Large	0 to 46 mm (0 to 1.81")	11 mm (0.43")	117 mm (4.61")	30392241

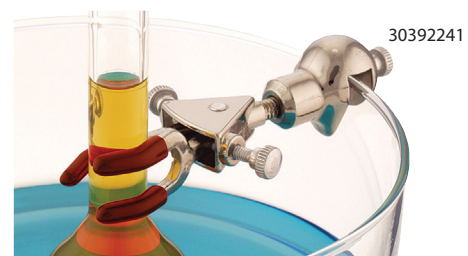
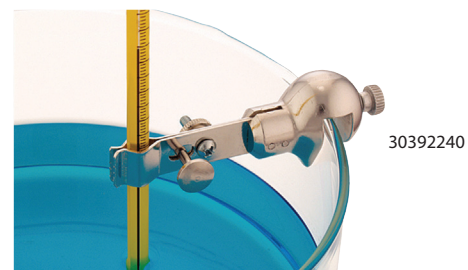

# LabJaws Clamps & Supports

## Specialty Clamps

For the items listed below an additional holder must be purchased in order to attach clamps to frames or other apparatus. See the Connectors & Holders section of this catalog, pages 92-95.

### Chain Clamps

Holds large round or irregular shaped objects firmly, yet gently, to lab-frames and rods. Quick and secure slip-on chain connection with large, easy-to-turn adjusting knob. Extension arm allows user to vary distance from the frame. Available as stainless steel clamp, constructed entirely of stainless steel with electro-polished finish or nickel-plated zinc clamp with strong, chromed-brass chain.

#### Stainless Steel

Size	Min. to Max. Dia.	Ext. Arm Length	Arm Dia.	Overall Length	Item Number
Large-5	35 to 280 mm (1.38 to 11.02")	127 mm (5")	13 mm (0.51")	206 mm (8.11")	30392224

#### Nickel-Plated Zinc

Size	Min. to Max. Dia.	Ext. Arm Length	Arm Dia.	Overall Length	Item Number
Small	35 to 170 mm (1.38 to 6.69")	127 mm (5")	13 mm (0.51")	188 mm (7.4")	30392235
Large-5	35 to 280 mm (1.38 to 11.02")	127 mm (5")	13 mm (0.51")	206 mm (8.11")	30392259
Large-12	35 to 280 mm (1.38 to 11.02")	305 mm (12")	13 mm (0.51")	384 mm (15.12")	30392260



30392224  
(shown in stainless steel)

### Column Clamps

These sturdy, easily adjusted, multi-purpose clamps are ideal for holding large cylindrical glassware and similar objects. A large, flat thumbscrew/worm-drive permits maximum tightening or removal in minimum time. Clamp is constructed of corrosion-resistant stainless steel. Ideal for chromatography columns.

Size	Min. to Max. Dia.	Ext. Arm Length	Arm Dia.	Overall Length	Item Number
Small	65 to 89 mm (2.56 to 3.5")	211 mm (8.31")	11 mm (0.43")	282 mm (11.1")	30392314
Medium	91 to 114 mm (3.58 to 4.49")	211 mm (8.31")	11 mm (0.43")	315 mm (12.4")	30392315
Large	64 to 140 mm (2.52 to 5.51")	211 mm (8.31")	11 mm (0.43")	338 mm (13.31")	30392316
X-Large	92 to 165 mm (3.62 to 6.5")	211 mm (8.31")	11 mm (0.43")	368 mm (14.49")	30392317



30392316

### Nester Extension Clamps

Securely holds large or small glass distillation columns and odd-shaped glassware. Constructed of stainless steel with strong, chromed-brass band and chain.

Min. to Max. Dia.	Ext. Arm Length	Arm Dia.	Overall Length	Item Number
50 to 102 mm (1.97 to 4")	152 mm (5.98")	10 mm (0.39")	262 mm (10.32")	30392318



30392318

### PVC Coated Open Extension Rings

Ideal for supporting funnels, round bottom flasks, reaction vessels, and other apparatus that require lower support. Opening in PVC coated aluminum ring allows for easy removal of sample container. PVC coating protects glassware. Long extension arm permits depth adjustment of the open ring from the lab-frame or ring stand.

Ring Dia.	Ext. Arm Length	Arm Dia.	Overall Length	Item Number
76 mm (3")	254 mm (10")	9 mm (0.35")	328 mm (12.91")	30392346
102 mm (4")	305 mm (12")	9 mm (0.35")	404 mm (15.91")	30392347
127 mm (5")	305 mm (12")	11 mm (0.43")	427 mm (16.81")	30392348



30392347

### Open Rings

Lightweight rings mount funnels, boiling flasks, and other irregular shaped objects to lab-frames. Open ring section allows items to pass in and out of support area easily, reducing risk of breakage. Aluminum construction.

Ring Dia.	Ext. Arm Length	Arm Dia.	Overall Length	Item Number
76 mm (3")	58 mm (2.28")	9 mm (0.35")	132 mm (5.2")	30392343
102 mm (4")	58 mm (2.28")	9 mm (0.35")	158 mm (6.22")	30392344
127 mm (5")	61 mm (2.4")	11 mm (0.43")	183 mm (7.2")	30392345



30392345



## Specialty Clamps

### Buret Holders

Stainless steel electro-polished finish or nickel-plated zinc construction. Double Buret Clamp holds any size buret from micro to 100 mL capacity. Simply compress the scissor-like mechanism, insert buret and gently release to grip. Numbers and graduation on buret remain easy to read. For height adjustments, recompress mechanism and slide buret up or down and gently release. Clamp unit with built-in reinforced hook connector attaches to optional standard support rod. Adjusting nut faces forward for easy use. Stainless steel or aluminum support rod attaches to optional porcelain base.

**Support Rod** (Dia. × L): 13 × 578 mm (0.51 × 22.76")

**Porcelain Base** (L × W × H): 178 × 330 × 25 mm (7 × 13 × 1")

#### Stainless Steel

Description	Item Number
Double Buret Clamp (only)	30392227
Support Rod (only)	30392233
Support Stand with Rod	30392232
Double Buret Clamp & Support Stand with Rod (complete)	

#### Nickel-Plated Zinc

Description	Item Number
Double Buret Clamp (only)	30392234
Support Stand with Rod	30392312
Double Buret Clamp & Support Stand with Rod (complete)	30392313



30392231  
(shown in stainless steel)

### Kettle Clamps

Holds flask and cover together firmly. Three insulated spring-activated clamping arms. Stainless steel springs. For use on reaction kettles.

Flask Size	Inside Dia.	Item Number
500 mL, 1000 mL	125 mm (4.92")	30392365
2000 mL, 3000 mL, 4000 mL	142 mm (5.59")	30392366



30392365

### Electrode Support Clamp

Permits suspension of electrodes over beaker for potentiometric titrations. Holds any electrode clamp at desired level. Built-in nickel-plated zinc holder grips rods up to 19 mm (0.75") in diameter.

Overall Length	Item Number
178 mm (7")	30392242

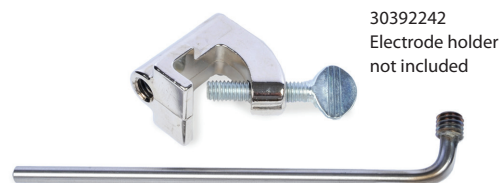

30392242  
Electrode holder  
not included

### Suspension Clamp

Holds thermometers, potash bulbs or drying tubes 114 mm (4.49") from support rod. Machine tapered, nickel-plated brass hook won't bend, rust, or corrode. Built-in holder grips rods up to 19 mm (0.75") in diameter.

Overall Length	Item Number
137 mm (5.39")	30392243



30392243

### Support Clamp

Supports electrolysis apparatus, glass rods or tubing at any angle. Arms are nickel-plated brass with vinyl coating. Easily supports cylindrical objects up to 19 mm (0.75") in diameter. Built-in holder grips rods up to 19 mm (0.75") in diameter.

Overall Length	Prong Width	Item Number
152 mm (5.99")	25 mm (1")	30392237

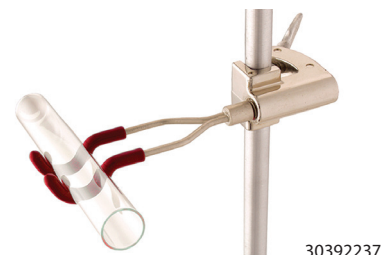

30392237

# LabJaws Clamps & Supports

## Specialty Clamps

Ultra Flex Support Systems have unique flexible arms that are extremely versatile and can be placed in virtually any position or angle. Ultra Flex comes in three different systems; base plate, lab-frame connector, and bench clamp. Each system includes a 2-Prong Clamp Head, 3-Prong Clamp Head, Spring Clamp Head, nickel-plated flex arm in 305 mm (12") or 457 mm (18") length, and utility wrench. 2-prong and 3-prong clamp heads also supplied with non-slip vinyl sleeves and, for temperatures above 100°C, fiberglass covers.

Arm Length	Ultra Flex 12 Ultra Flex 18	305 mm (12") 457 mm (18")
Arm Diameter		13 mm (0.51")
Max. Grip Size	2-Prong Clamp Head 3-Prong Clamp Head Spring Clamp Head	75 mm (2.95") 69 mm (2.72") 13 mm (0.51")

2-Prong Clamp Head

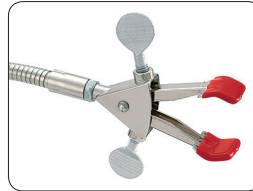

3-Prong Clamp Head

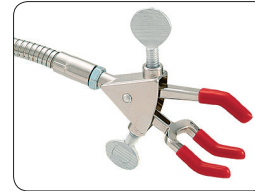

Spring Clamp Head

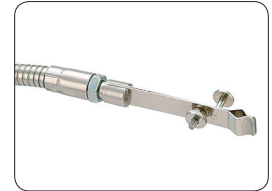

### Ultra Flex Support System with Base Plate

OHAUS Ultra Flex Support System with Base Plate is constructed of all metal and designed with a stable, painted steel base plate with chemical resistant black finish that fits easily on bench tops or in fume hoods. Base plate measures 127 × 127 × 12.7 mm (5 × 5 × 0.5").

Description	Item Number
Ultra Flex 12 with Base Plate	30400011
Ultra Flex 18 with Base Plate	30400014

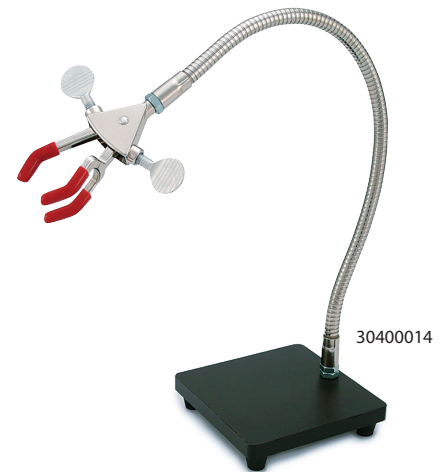

### Ultra Flex Support System with Lab-Frame Connector

Ultra Flex Support System with Lab-Frame Connector securely attaches to support stands, lab-frames, or any support rod up to 19 mm (0.75") in diameter. Ideal for use in fume hoods. Lab-frame connector is made of cast alloy.

Description	Item Number
Ultra Flex 12 with Lab-Frame Connector	30400013
Ultra Flex 18 with Lab-Frame Connector	30400016

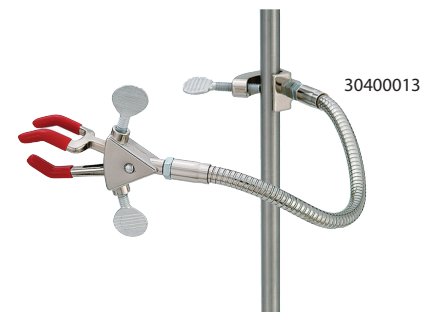

### Ultra Flex Support System with Bench Clamp

Ultra Flex Support System with Bench Clamp easily attaches to the side of your lab bench or counter top, which helps utilize more space in your lab. Bench clamp is constructed of aluminum.

Description	Item Number
Ultra Flex 12 with Bench Clamp	30400012
Ultra Flex 18 with Bench Clamp	30400015



## Specialty Clamps

### Bench Clamp

Aluminum bracket with arm fastens quickly and firmly to any convenient shelf. Accepts 13 mm (0.51") rods vertically and horizontally, to which ordinary rings and clamps attach, leaving bench surface clear for apparatus.

Clamp Opening	Depth of Grip	Overall Length	Item Number
1.7" (43 mm)	2" (51 mm)	7.75" (197 mm)	30392311

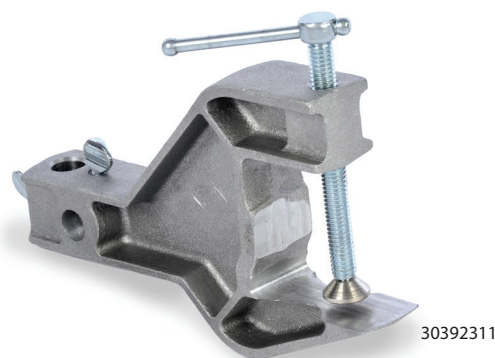

### Thumbscrew Knob

Thumbscrew tightening knob features a 32 mm (1.25") slot in the center of a nylon disc that will accept thumbscrews supplied with the LabJaws and UltraJaws Multi-Purpose Clamps, excluding the stainless steel version. Makes tightening of clamps easier on the hands and wrists.

Overall Diameter	Thumbscrew Slot	Item Number
64 mm (2.5")	32 mm (1.25")	30392192

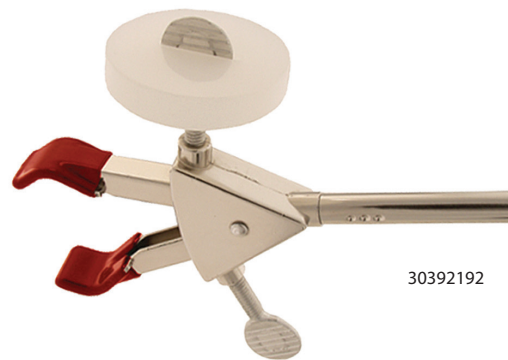

### Double Jaw Utility Clamp

Swivels 360° and locks securely in desired position. These 2-prong clamps have a medium and a large clamp on each end. Nickel-plated zinc construction. Supplied with non-slip vinyl sleeves and, for temperatures above 100°C, fiberglass covers.



Description	Min. to Max. Grip Size	Prong Width	Overall Length	Item Number
Medium 2-Prong	0 to 76 mm (0 to 3")	23 mm (0.91")	222 mm (8.74")	30392236



# Connectors & Holders



LabJaws offers a range of holders and connectors to customize the attachment of clamps to lab-frames at specific angles and diameters. Holders are used to attach clamps to lab-frames and support rods in order to secure apparatus. Connectors are used to join lab-frames and rods in the same plane or at 90° angles, utilizing set screws which allow for individual adjustment of each rod location.

- Three Materials to Choose From to Best Suit Your Needs
- Select Holders Based on the Diameter of the Clamp and Lab-Frame or Support Rod
- Versatile Range of Connectors for Easy Assembly of Rods

## Connectors & Holders

### Regular Holder

Stainless steel electro-polished finish or nickel-plated zinc construction. Ideal for holding clamps to lab-frames. Use wherever clamping at 90° is required.

Material	Min. to Max. Grip Size	Item Number
Stainless steel	0 to 18 mm (0 to 0.71")	30392219
Nickel-plated zinc	0 to 18 mm (0 to 0.71")	30392197



30392219  
(shown in stainless steel)

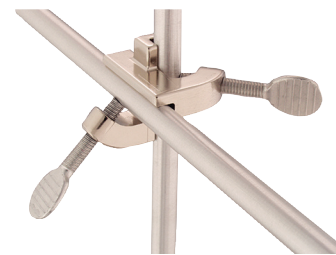

30392197  
(shown in nickel-plated zinc)

### Jumbo Holder

Stainless steel electro-polished finish or aluminum construction. Ideal for holding clamps to lab-frames or ring stands.

Material	Min. to Max. Grip Size	Item Number
Stainless steel	0 to 21 mm (0 to 0.83")	30392357
Aluminum	0 to 21 mm (0 to 0.83")	30392196



30392357  
(shown in stainless steel)



30392196  
(shown in aluminum)

### Heavy-Duty Holder

For mounting stirrers and other apparatus. Holder is constructed of strong aluminum alloy; fitted with oversized knobs for very secure positioning. Rods supported on 102 mm (4") long surface to avoid vibration and wobble.

Material	Min. to Max. Grip Size	Item Number
Aluminum	6 to 24 mm (0.24 to 0.95")	30400045

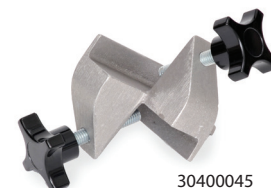

30400045

### Swivel Holder

Two rod holders with center swivel capacity allow tilting of clamps at any angle in parallel planes. Outside adjustment screw allows close proximity between items being held. Stainless steel electro-polished or nickel-plated zinc construction.

Material	Min. to Max. Grip Size	Item Number
Stainless steel	0 to 19 mm (0 to 0.75")	30392228
Nickel-plated zinc	0 to 19 mm (0 to 0.75")	30392213



30392228  
(shown in stainless steel)



30392213  
(shown in nickel-plated zinc)

### All-Position Clamp Holder

Surpasses standard holding capabilities. The all-position clamp holder permits adjustment at any angle in any plane. Holders are set at 90° to each other, connected by a 90° connector, allowing 360° rotation. Nickel-plated zinc construction.

Material	Min. to Max. Grip Size	Item Number
Nickel-plated zinc	0 to 19 mm (0 to 0.75")	30392248



30392248

### Clamp Holder

Clamp is ideal for gripping 2 rods at 90°. Oversized thumbscrews make securing rods fast and easy.

Material	Min. to Max. Grip Size	Overall Length	Item Number
Aluminum	0 to 17 mm (0 to 0.66")	70 mm (2.75")	30392195



30392195

# LabJaws Clamps & Supports

## Connectors & Holders

### Hook Connector

Stainless steel electro-polished finish or nickel-plated zinc construction. Simple, versatile, and easy-to-use. Hook connectors allow one-handed assembly of two components with one adjustment screw.

Material	Min. to Max. Grip Size	Item Number
Stainless steel	0 to 13 mm (0 to 0.51")	30392358
Nickel-plated zinc	0 to 13 mm (0 to 0.51")	30392258



30392358  
(shown in stainless steel)



30392258  
(shown in nickel-plated zinc)

### End-to-End Connector

Extend the length of lab-frame rods. Strong aluminum alloy connector permits end-to-end joining of rods. Precision boring of connector ensures perfect alignment of rods. Corrosion resistant. Comes with two set screws.

Material	Min. to Max. Grip Size	Item Number
Aluminum	0 to 13 mm (0 to 0.51")	30392264



30392264

### Rod End Connector

Holds rods firmly at 90°. Use when semi-permanent installations are required. Comes with two set screws and is precision bored for close fit. Stainless steel electro-polished finish or nickel-plated zinc construction.

Material	Min. to Max. Grip Size	Item Number
Stainless steel	0 to 13 mm (0 to 0.51")	30392222
Nickel-plated zinc	0 to 13 mm (0 to 0.51")	30392256

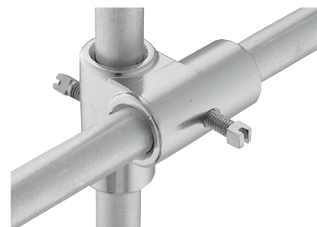

30392222  
(shown in stainless steel)

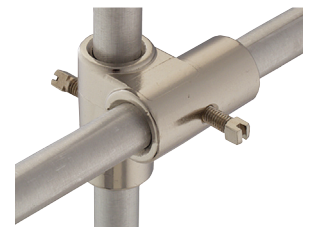

30392256  
(shown in nickel-plated zinc)

### S-Connector

Stainless steel electro-polished finish or nickel-plated zinc construction. Clamp is ideal for constructing lab-frames or other supports requiring the connection of two perpendicular rods. Clamp connects two 13 mm (0.51") rods at a 90° angle and features separate adjustment screws for each rod location.

Material	Min. to Max. Grip Size	Item Number
Stainless steel	0 to 13 mm (0 to 0.51")	30392355
Nickel-plated zinc	0 to 13 mm (0 to 0.51")	30392257

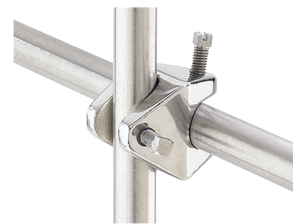

30392355  
(shown in stainless steel)

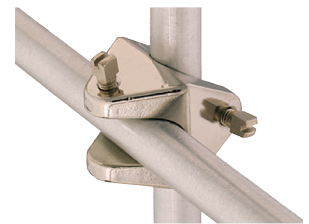

30392257  
(shown in nickel-plated zinc)

### Frame Connector (Pack of 12)

Improved contour delivers simplicity and strength. Angled adjustment screws allow easy set-up and prevents misalignment. Smooth, rounded surfaces are easy-to-clean. Small size maximizes lab-frame space. Bright dipped aluminum finish sealed with silicon for maximum protection against corrosion.

Material	Min. to Max. Grip Size	Item Number
Aluminum	0 to 13 mm (0 to 0.51")	30392255



30392255

## Connectors & Holders

### Universal Stirrer Mounting Bracket

Use to mount stirrers and other devices to lab-frames. Aluminum mounting bracket with attachment screws.

Max. Weight Mounted	Min. to Max. Grip Size	Item Number
2.27 kg (5 lbs)	0 to 20 mm (0 to 0.78")	30392265

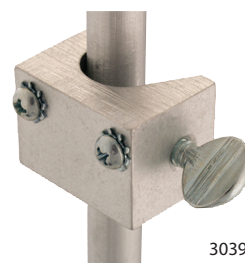

30392265

### Multi-Rod Connector

Maximum adjustment capability within one connector. Two adjustment rods fit into the oval hole in the connector, preventing turning when tightened. Side and front 13 mm (0.51") holes allow creation of a variety of configurations. Nickel-plated zinc construction.

Min. to Max. Rod Size	Item Number
0 to 13 mm (0 to 0.51")	30392262

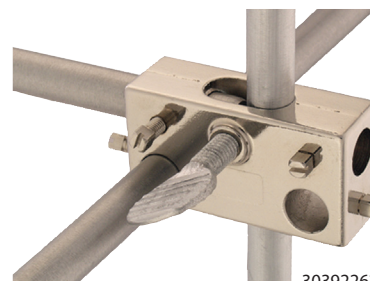

30392262

### Wrench

Special adjusting wrench is for use with lab-frame items with set screws.

Length	Item Number
79 mm (3.11")	30392270



30392270

### Channel Connector

Special connector fastens lab-frame rod to steel 41 mm (1.61") channels. Loosen the connector and slide up or down for easy adjustment of rod position.

Dimensions	Item Number
33 x 40 mm (1.3 x 1.58")	30392261

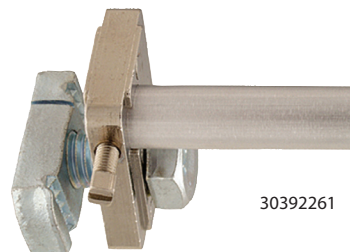

30392261

### Horizontal Mounting Bars with Coupler

Threaded end for direct installation into channels. Comes with spring coupler for use in steel 41 mm (1.61") channels. Locking nut included. Use with steel channel frames.

Bar Length	Item Number
51 mm (2")	30392266
102 mm (4")	30392267
152 mm (6")	30392268
203 mm (8")	30392269

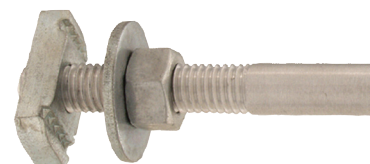

30392268



# Rods, Frames, & Supports



LabJaws offers the largest selection of Lab-Frame Kits, Lab-Lifts, Rods and Support Stands in the industry to hold glassware safely. Whether you're looking for a standard lab-frame or a customizable set-up, we have options to fit any space or application. Select from 14 pre-configured lab-frame kits (connectors and feet included) to rods which can be purchased individually and combined with LabJaws accessories to build a customized frame.

- Choose from Stainless Steel and Aluminum Options to Best Suit Your Application
- Range of Pre-Configured Lab-Frame Kits and Customizable Rods for Your Lab Space
- Lab-Lifts Provide Exceptional Stability to Hold Items at Varying Heights

## Rods, Frames, & Supports

### Lab Frame Foot

Stainless steel electro-polished finish or nickel-plated zinc construction. Strong, durable lab-frame foot is designed for mounting lab-frames permanently to bench tops, fume hoods, walls, and floors. Spilled fluids roll right off the smooth body contour, minimizing contamination and easing clean-ups. Features a set screw and includes three 19 mm (0.75") mounting screws.

Material	Min. to Max. Grip Size	Dimensions (Dia. × H)	Item Number
Stainless steel	0 to 0.51" (0 to 13 mm)	2.3 × 1.25" (58 × 32 mm)	30392356
Nickel-plated zinc	0 to 0.51" (0 to 13 mm)	2.3 × 1.25" (58 × 32 mm)	30392263



30392356  
(shown in stainless steel)

### Frame Rods

Everything you need to customize a lab-frame to your laboratory space. Quality construction throughout. Frame rods are available in many lengths and materials.

#### Aluminum

Center-less ground for a precise fit. These hard aluminum rods provide a smooth fit with lab-frames. Corrosion resistant with chamfered ends for easy location.

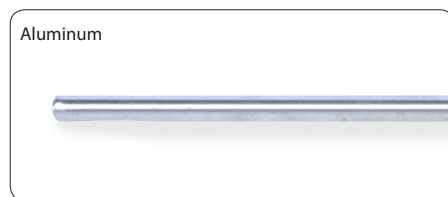

#### Stainless Steel

Heavy-duty, top-of-the-line rods provide maximum strength and durability. Constructed of 303 stainless steel.

Rod Diameter	Rod Length	Aluminum Item Number	Stainless Steel Item Number
0.51" (13 mm)	1.61" (41 mm)	30392271	30392293
0.51" (13 mm)	2" (51 mm)	30392272	30392294
0.51" (13 mm)	6" (152 mm)	30392273	30392295
0.51" (13 mm)	12" (305 mm)	30392274	30392296
0.51" (13 mm)	18" (457 mm)	30392275	30392297
0.51" (13 mm)	24" (610 mm)	30392276	30392298
0.51" (13 mm)	36" (914 mm)	30392277	30392299
0.51" (13 mm)	48" (1219 mm)	30392278	30392300
0.51" (13 mm)	60" (1524 mm)	30392279	30392301
0.51" (13 mm)	72" (1829 mm)	30392280	30392302
0.51" (13 mm)	96" (2438 mm)	30392281	30392303

# LabJaws Clamps & Supports

## Rods, Frames, & Supports

LabJaws offers the widest choice of standard lab frames available, plus the accessories to custom-fit any laboratory with the right frame for the job. Standard Lab-Frame sets are available in five sizes. Options of traditional center-less ground aluminum, non-corroding fiberglass, or tough stainless steel rods are available. Nickel-plated zinc connectors and lab-frame feet are standard with all kits.

### Small Lab-Frame

Vertical mounting, great for glassware set-ups in small laboratories or where space is limited. Frame measures 24 × 24" (610 × 610 mm). Base is 18" (457 mm) wide for stability. Base may be permanently mounted to bench top with screws (included).

#### Components:

- (8) 2" (51 mm) Rods
- (2) 18" (457 mm) Rods
- (8) 24" (610 mm) Rods
- (18) S-Connectors
- (4) Rod End Connectors
- (4) Lab-Frame Feet



Frame Dimensions	Base Dimensions	Aluminum Item Number	Stainless Steel Item Number
24 × 24" (610 × 610 mm)	18" (457 mm) wide	30392304	30392323

### Medium Lab-Frame

Horizontal or vertical mounting, convenient for distillation or general set-up. Frame measures 24 × 48" (610 × 1219 mm). Base is 18" (457 mm) wide for stability.

#### Components:

- (8) 2" (51 mm) Rods
- (2) 18" (457 mm) Rods
- (7) 24" (610 mm) Rods
- (4) 48" (1219 mm) Rods
- (35) S-Connectors
- (4) Rod End Connectors
- (4) Lab-Frame Feet

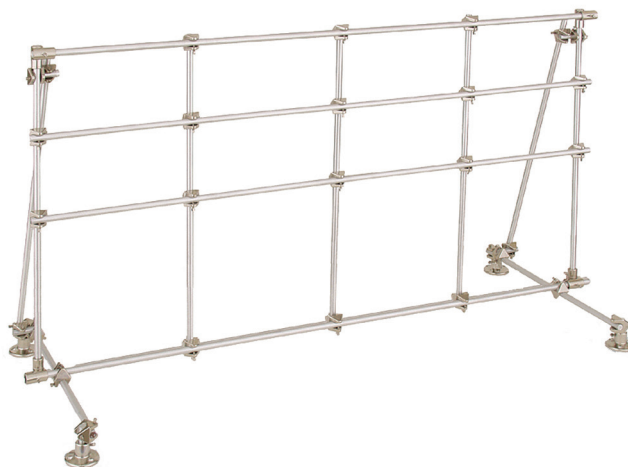

Frame Dimensions	Base Dimensions	Aluminum Item Number	Stainless Steel Item Number
24 × 48" (610 × 1219 mm)	18" (457 mm) wide	30392305	30392324

## Rods, Frames, & Supports

### Large Lab-Frame

This 48 × 48" (1219 × 1219 mm) frame is ideal for complex glassware set-ups. Base is 18" (457 mm) wide for stability.

#### Components:

- (10) 2" (51 mm) rods
- (3) 18" (457 mm) rods
- (2) 36" (914 mm) rods
- (10) 48" (1219 mm) rods
- (38) S-Connectors
- (4) Rod End Connectors
- (6) Lab-Frame Feet



Frame Dimensions	Base Dimensions	Aluminum Item Number	Stainless Steel Item Number
48 × 48" (1219 × 1219 mm)	18" (457 mm) wide	30392306	30392325

### Extra-Large Lab-Frame

Versatile, adaptable Extra-Large Lab-Frame measures 48 × 72" (1219 × 1829 mm) and may be used either horizontally or vertically.

#### Components:

- (6) 2" (51 mm) rods
- (6) 12" (305 mm) rods
- (2) 24" (610 mm) rods
- (7) 48" (1219 mm) rods
- (5) 72" (1829 mm) rods
- (45) S-Connectors
- (4) Rod End Connectors
- (8) Lab-Frame Feet



Frame Dimensions	Aluminum Item Number	Stainless Steel Item Number
48 × 72" (1219 × 1829 mm)	30392307	30392326



# LabJaws Clamps & Supports

## Rods, Frames, & Supports

### Heavy-Duty Lab-Frame

Floor mounted, free-standing unit is specifically designed for heavy-duty work such as pilot plant set-ups. Outside frame is constructed of a strong, but lightweight steel channel. Interior lattice uses a horizontal channel connector; one end accommodates the rod, the other end fits into the channel and locks tightly with a bolt. Loosen the bolt, and the connector slides easily along the channel track for simple lattice adjustment. Entire apparatus is supported on sturdy, counter-weighted cast iron feet, which may be bolted to the floor for added stability required in top-heavy installations.

#### Components:

- (5) 48" (1219 mm) rods
- (3) 72" (1829 mm) rods
- (15) S-Connectors
- (16) Channel Connectors
- (24) Clamping Nuts
- (2) 21.7" (551 mm) Cast Iron Feet
- (1) Frame Kit
- (1) Wrench



Frame Dimensions	Overall Dimensions	Aluminum Item Number	Stainless Steel Item Number
48 × 72" (1219 × 1829 mm)	75 × 72" (1905 × 1829 mm)	30392309	30392328

### Fume Hood Kits

Choose from four kits specifically designed to fit within laboratory fume hoods. All components are constructed of stainless steel with the exception of the Frame Connectors which are made of aluminum with a silicon finish.

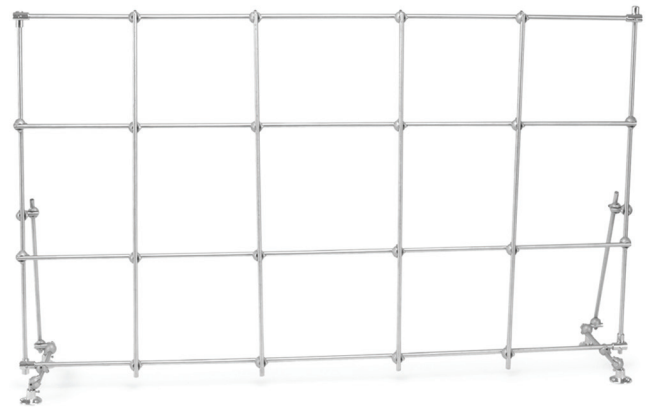

4' (1.22 m) Fume Hood Kit		5' (1.52 m) Fume Hood Kit		6' (1.83 m) Fume Hood Kit		8' (2.44 m) Fume Hood Kit	
<b>Components:</b> <ul style="list-style-type: none"> <li>• (8) 2" (51 mm) rods</li> <li>• (2) 12" (305 mm) rods</li> <li>• (2) 18" (457 mm) rods</li> <li>• (4) 36" (914 mm) rods</li> <li>• (4) 38" (965 mm) rods</li> <li>• (30) Frame Connectors</li> <li>• (4) Rod End Connectors</li> <li>• (4) Lab-Frame Feet</li> </ul> Frame: 36 × 38" (914 × 965 mm) Base: 12" (305 mm) wide		<b>Components:</b> <ul style="list-style-type: none"> <li>• (8) 2" (51 mm) rods</li> <li>• (2) 12" (305 mm) rods</li> <li>• (2) 18" (457 mm) rods</li> <li>• (5) 36" (914 mm) rods</li> <li>• (4) 50" (1270 mm) rods</li> <li>• (34) Frame Connectors</li> <li>• (4) Rod End Connectors</li> <li>• (4) Lab-Frame Feet</li> </ul> Frame: 36 × 50" (914 × 1270 mm) Base: 12" (305 mm) wide		<b>Components:</b> <ul style="list-style-type: none"> <li>• (8) 2" (51 mm) rods</li> <li>• (2) 12" (305 mm) rods</li> <li>• (2) 18" (457 mm) rods</li> <li>• (6) 36" (914 mm) rods</li> <li>• (4) 62" (1575 mm) rods</li> <li>• (38) Frame Connectors</li> <li>• (4) Rod End Connectors</li> <li>• (4) Lab-Frame Feet</li> </ul> Frame: 36 × 62" (914 × 1575 mm) Base: 12" (305 mm) wide		<b>Components:</b> <ul style="list-style-type: none"> <li>• (10) 2" (51 mm) rods</li> <li>• (3) 12" (305 mm) rods</li> <li>• (2) 18" (457 mm) rods</li> <li>• (8) 36" (914 mm) rods</li> <li>• (4) 86" (2184 mm) rods</li> <li>• (45) Frame Connectors</li> <li>• (4) Rod End Connectors</li> <li>• (6) Lab-Frame Feet</li> </ul> Frame: 36 × 86" (914 × 2184 mm) Base: 12" (305 mm) wide	
<b>Item Number</b>	30392329	<b>Item Number</b>	30392330	<b>Item Number</b>	30392331	<b>Item Number</b>	30392332

## Rods, Frames, & Supports

### Support Stands

Support Stands are made entirely of 303 stainless steel. They have a durable base that can accommodate vessels up to 18" (457 mm) in diameter within the "U". The base area is 17.75" (451 mm) across x 10.5" (267 mm) deep overall. The stainless steel support rod is 0.63" (16 mm) in diameter and is screwed to the support base. Two additional threaded holes in the base legs accommodate rods, enabling the stand to support two mixers. The "U" shape of the base should be turned from the mixing apparatus when the two outside rods are in use. This balances the weight, preventing the base from tipping.

Description	Item Number
Support Stand with 23" (584 mm) Rod	30400030
Support Stand with 28" (711 mm) Rod	30400031
Support Stand with 36" (914 mm) Rod	30400032
Support Stand with 40" (1016 mm) Rod	30400033
Support Stand with 48" (1219 mm) Rod	30400034
Support Stand with 60" (1524 mm) Rod	30400035



Support Stand

### Support Stand Stabilizer Knobs

Support Stand Stabilizer Knobs can be added to the two additional threaded holes in the base legs to secure the stand to a bench top.

Description	Item Number
Support Stand Stabilizer Knobs (2 per pack)	30400044



Support Stand Stabilizer Knobs

### Heavy-Duty Support Stands

Heavy-Duty Support Stands have a four point cast iron base with stainless steel support rod. They are designed to accommodate vessels up to 12" (30.5 cm) in diameter to sit close to the support rod. They have rubber cushions on each of the four corners. The base area is 16.5" (41.9 cm) across x 12" (30.5 cm) deep overall. They are ideal for Heavy-Duty Mixers, page 54-56.

Description	Item Number
Heavy-Duty Support Stand with 18" (457 mm) Rod	30392334
Heavy-Duty Support Stand with 23" (584 mm) Rod	30392335
Heavy-Duty Support Stand with 28" (711 mm) Rod	30392336
Heavy-Duty Support Stand with 36" (914 mm) Rod	30392337
Heavy-Duty Support Stand with 40" (1016 mm) Rod	30392338
Heavy-Duty Support Stand with 48" (1219 mm) Rod	30392339
Heavy-Duty Support Stand with 60" (1524 mm) Rod	30392340



Heavy-Duty Support Stand

### Replacement Support Rods

Description	Diameter	Item Number
18" (457 mm) Stainless Steel Rod	0.63" (16 mm)	30400036
23" (584 mm) Stainless Steel Rod	0.63" (16 mm)	30400037
28" (711 mm) Stainless Steel Rod	0.63" (16 mm)	30400038
36" (914 mm) Stainless Steel Rod	0.63" (16 mm)	30400039
40" (1016 mm) Stainless Steel Rod	0.63" (16 mm)	30400040
48" (1219 mm) Stainless Steel Rod	0.63" (16 mm)	30400041
60" (1524 mm) Stainless Steel Rod	0.63" (16 mm)	30400042



Replacement Support Rods

# LabJaws Clamps & Supports

## Rods, Frames, & Supports

### Cast Iron Support Stands

Cast iron support stand bases are constructed with black enamel finish for chemical resistance and durability. All bases feature a built-in support rod holder with locking knob that accepts a 0.51" (13 mm) diameter support rod. U-shaped base features three built-in support rod holders and accommodates vessels up to 5" (127 mm) in diameter.

**NOTE:** Support rods are not included.

### Rectangular Base Support Stand, Cast Iron

Description	Dimensions	Item Number
Rectangular Base (only)	4 × 6" (102 × 152 mm)	30392359
Rectangular Base (only)	5 × 8" (127 × 203 mm)	30392360
Rectangular Base (only)	6 × 9" (152 × 229 mm)	30392361
Rectangular Base (only)	8 × 10" (203 × 254 mm)	30392362



### Tripod Base Support Stand, Cast Iron

Description	Overall Footprint Diameter	Item Number
Tripod Base (only)	14.75" (375 mm)	30392363



### U-Shaped Base Support Stand, Cast Iron

Description	Dimensions	Item Number
U-Shaped Base (only)	7 × 7" (178 × 178 mm)	30392364



### Aluminum Support Rods

Description	Diameter	Item Number
12" (305 mm) Aluminum Rod	0.51" (13 mm)	30392274
18" (457 mm) Aluminum Rod	0.51" (13 mm)	30392275
24" (610 mm) Aluminum Rod	0.51" (13 mm)	30392276
36" (914 mm) Aluminum Rod	0.51" (13 mm)	30392277



### Stainless Steel Support Rods

Description	Diameter	Item Number
12" (305 mm) Stainless Steel Rod	0.51" (13 mm)	30392296
18" (457 mm) Stainless Steel Rod	0.51" (13 mm)	30392297
24" (610 mm) Stainless Steel Rod	0.51" (13 mm)	30392298
36" (914 mm) Stainless Steel Rod	0.51" (13 mm)	30392299



## Rods, Frames, & Supports

### Round Support Plate

Aluminum plate supports beakers, mantles and petri dishes. Fits standard lab-frames using connectors or holders, shown on pages 92-95.

Description	Distance from Rod	Item Number
6" (152 mm)	2.6" (66 mm)	30392342



### Support Plates

Designed to hold hotplates, stirrers, hotplate-stirrers, and other apparatus to lab-frames or ring stands. Aluminum construction offers strength and durability. Support plates include a non-skid rubber mat and a built-in holder that grips rods up to 0.75" (19 mm) in diameter.

Size	Plate Dimensions	Distance from Rod	Item Number
Small	9.5 × 6.5" (241 × 165 mm)	1.9" (48 mm)	30392349
Medium	12.75 × 9" (324 × 229 mm)	1.9" (48 mm)	30392350
Large	15.75 × 12" (400 × 305 mm)	1.9" (48 mm)	30392351

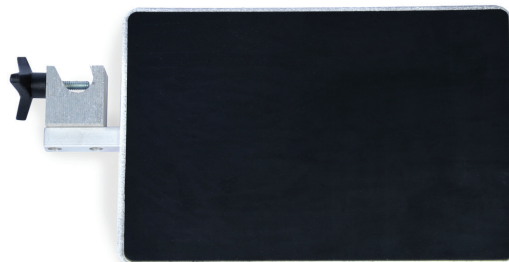



# LabJaws Clamps & Supports

## Rods, Frames, & Supports

### OHAUS Aluminum Lab-Lifts

- Exceptional stability and durability
- Aluminum construction
- Three convenient sizes

Aluminum Lab-Lifts provide stable height adjustment for various items in the lab such as flasks, baths, and small equipment. Top and bottom decks are constructed of anodized aluminum. Internal supports and drive screws are constructed of stainless steel. Oversized sure-grip adjustment knobs provide smooth and accurate height adjustment. Lab-Lifts accept optional Support Rod Kit which mounts to the upper deck.

Deck Size	Min. to Max. Height	Max. Load*	Item Number
4 × 4" (102 × 102 mm)	2.5 to 5" (64 to 127 mm)	66 lbs (29.94 kg)	30400007
6 × 6" (152 × 152 mm)	3 to 9.75" (76 to 248 mm)	132 lbs (59.87 kg)	30400008
8 × 8" (203 × 203 mm)	3 to 9.75" (76 to 248 mm)	176 lbs (79.83 kg)	30400009
10 × 10" (254 × 254 mm)	3.5 to 13" (89 to 330 mm)	186 lbs (84.37 kg)	30400010

\*NOTE: Maximum load rating represents static weight only. Static weight is the amount a unit can hold, not lift.



### OPTIONAL ACCESSORIES

#### 17" Support Rod Kit

Ideal for creating an adjustable support stand for mounting various items such as thermometer clamps, temperature probes, flask and column clamps. This kit allows you to mount a 17" (432 mm) threaded vertical support rod to the upper deck of a 6 × 6", 8 × 8", 10 × 10", 12 × 12" or 16 × 16" Lab-Lift by screwing the rod into the pre-drilled hole.

#### 17" Support Rod Kit includes:

- 1 - 17" (432 mm) Stainless Steel Rod
- 1 - Jam Nut
- 1 - Flat Washer



Description	Rod Diameter	Item Number
17" Support Rod Kit	0.51" (13 mm)	30400050

## Rods, Frames, & Supports

### OHAUS Heavy-Duty Lab-Lifts

- Stainless steel construction
- Seven convenient sizes to choose from
- Autoclavable and chemical resistant

These Heavy-Duty, Stainless Steel Lab-Lifts are ultra-stable lifting platforms with exceptional strength and durability. Constructed of stainless steel, Lab-Lifts are designed for use in extreme environments and high load applications. Equipped with oversized, sure-grip adjustment knobs that provide extra leverage for easy height adjustments. Durable construction allows lifts to be autoclaved or chemically cleaned. Ideal for use in fume hoods or bench tops and holds a variety of items such as glassware, hotplates, baths, and magnetic stirrers.

Deck Size	Min. to Max. Height	Max. Load*	Item Number
3 × 3" (76 × 76 mm)	2.5 to 5" (64 to 127 mm)	100 lbs (45.36 kg)	30400000
4 × 4" (102 × 102 mm)	2.5 to 5" (64 to 127 mm)	100 lbs (45.36 kg)	30400001
6 × 6" (152 × 152 mm)	3 to 9.75" (76 to 248 mm)	133 lbs (60.33 kg)	30400002
8 × 8" (203 × 203 mm)	3 to 9.75" (76 to 248 mm)	227 lbs (102.97 kg)	30400003
10 × 10" (254 × 254 mm)	3.5 to 13" (89 to 330 mm)	247 lbs (112.04 kg)	30400004
12 × 12" (305 × 305 mm)	4 to 19.5" (102 to 495 mm)	100 lbs (45.36 kg)	30400005
16 × 16" (406 × 406 mm)	4 to 19.5" (102 to 495 mm)	100 lbs (45.36 kg)	30400006

\*NOTE: Maximum load rating represents static weight only. Static weight is the amount a unit can hold, not lift.



#### OPTIONAL ACCESSORIES

### 17" Support Rod Kit

Ideal for creating an adjustable support stand for mounting various items such as thermometer clamps, temperature probes, flask and column clamps. This kit allows you to mount a 17" (432 mm) threaded vertical support rod to the upper deck of a 6 × 6", 8 × 8", 10 × 10", 12 × 12" or 16 × 16" Lab-Lift by screwing the rod into the pre-drilled hole.

#### 17" Support Rod Kit includes:

- 1 - 17" (432 mm) Stainless Steel Rod
- 1 - Jam Nut
- 1 - Flat Washer

Description	Rod Diameter	Item Number
17" Support Rod Kit	0.51" (13 mm)	30400050



### Ratchet Tool

Designed to add extra leverage to your 12 × 12" or 16 × 16" Lab-Lift. This recommended Ratchet Tool easily attaches to the actuating rod to allow easy, accurate adjustments.

Description	Item Number
Ratchet Tool	30400049



# LabJaws Clamps & Supports

## Rods, Frames, & Supports

### Cylinder Bench Clamps

Rugged cast aluminum clamps safely secure gas cylinders to benches, tables or other flat surfaces up to 2.5" (64 mm) thick. The 1" (25 mm) wide, 54" (1372 mm) long nylon strap features a nickel-plated, non-slip spring catch and buckle for easy adjustment around cylinders from 4 to 14" (102 to 356 mm) in diameter. Models 711 and 716 available with or without a "Secure Cylinder" safety message strap.

### Model 711 Bench Clamp

This bench clamp has a large tightening handle for mounting to any flat surface up to 2.5" (64 mm) thick. A nylon pad prevents damage to the bench or table surface. Two tapered mounting screw holes are provided for permanent attachment to bench-top.

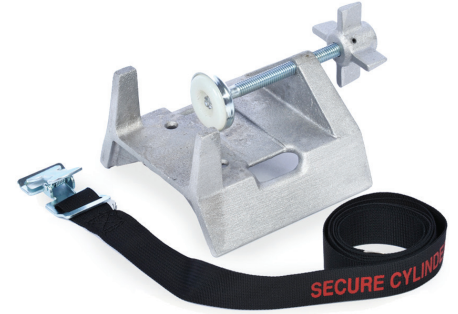
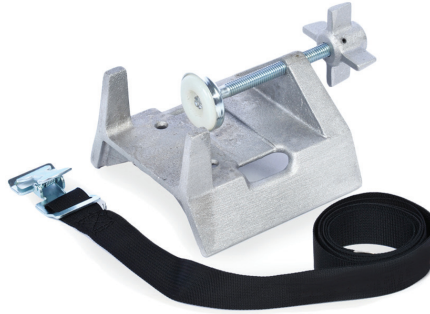

safety message strap

Description	Dimensions L x W x H (closed)	Cylinder Diameter	Item Number
Model 711 Bench Clamp with Strap	3.25 x 5.25 x 6.5" (83 x 133 x 165 mm)	4 to 14" (102 to 356 mm)	30400020
Model 711 Bench Clamp with Safety Message Strap	3.25 x 5.25 x 6.5" (83 x 133 x 165 mm)	4 to 14" (102 to 356 mm)	30400021

### Model 716 Bench Clamp

This bench clamp is similar to Model 711, but includes a sturdy safety chain for extra security. Chain measures 49" (1245 mm).

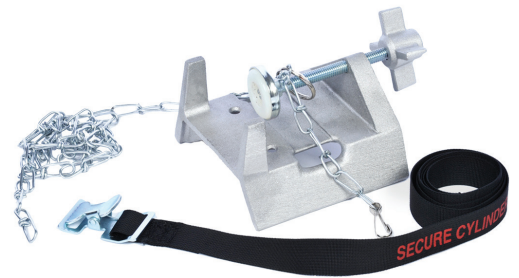
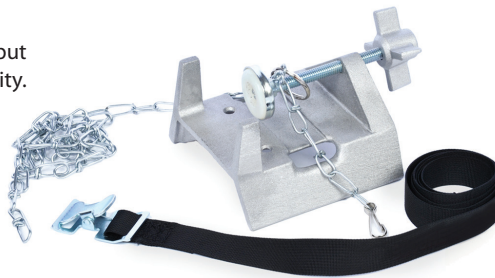

safety message strap

Description	Dimensions L x W x H (closed)	Cylinder Diameter	Item Number
Model 716 Bench Clamp with Strap & Chain	3.25 x 5.25 x 6.5" (83 x 133 x 165 mm)	4 to 14" (102 to 356 mm)	30400026
Model 716 Bench Clamp with Safety Message Strap & Chain	3.25 x 5.25 x 6.5" (83 x 133 x 165 mm)	4 to 14" (102 to 356 mm)	30400027

### Model 712 Heavy-Duty Bench Clamp

This bench clamp has two screw clamps to tighten for extra firm mounting to any flat surface up to 1.75" (45 mm) thick with a 1.25" (32 mm) overhang. Especially convenient for temporary storage situations. Rugged cast aluminum bench clamp features a 1" (25 mm) wide, 54" (1372 mm) long nylon strap with nickel-plated, non-slip spring catch buckle to hold cylinders from 4 to 14" (102 to 356 mm) in diameter. This clamp is not available with a safety message strap.



Description	Dimensions L x W x H (closed)	Cylinder Diameter	Item Number
Model 712 Heavy-Duty Bench Clamp with Strap	3.25 x 6 x 4.5" (83 x 152 x 114 mm)	4 to 14" (102 to 356 mm)	30400022

## Rods, Frames, & Supports

### Model 715 Wall Bracket

Cylinder wall-mount brackets are constructed of cast aluminum and contoured to allow cylinders to fit firmly along the support edge. Recessed screw holes at each side of the bracket allow for easy wall mounting. Features a 1" (25 mm) wide, 54" (1372 mm) long nylon strap with nickel-plated, non-slip spring catch and buckle for fast, easy adjustment. Available with or without a "Secure Cylinder" safety message strap. For cylinders from 4 to 14" (102 to 356 mm) in diameter.



safety message strap

Description	Dimensions L x W x H	Cylinder Diameter	Item Number
Model 715 Wall Bracket with Strap	1.88 x 8.13 x 4.63" (48 x 206 x 118 mm)	4 to 14" (102 to 356 mm)	30400024
Model 715 Wall Bracket with Safety Message Strap	1.88 x 8.13 x 4.63" (48 x 206 x 118 mm)	4 to 14" (102 to 356 mm)	30400025

### Model 717 Wall Bracket

This wall bracket is similar to Model 715, but includes a sturdy safety chain for extra security. Chain measures 49" (1245 mm).



safety message strap

Description	Dimensions L x W x H	Cylinder Diameter	Item Number
Model 717 Wall Bracket with Strap & Chain	1.88 x 8.13 x 4.63" (48 x 206 x 118 mm)	4 to 14" (102 to 356 mm)	30400028
Model 717 Wall Bracket with Safety Message Strap & Chain	1.88 x 8.13 x 4.63" (48 x 206 x 118 mm)	4 to 14" (102 to 356 mm)	30400029



# LabJaws Clamps & Supports

## Rods, Frames, & Supports

### Model 701 PVC Coated Stand

The PVC coated stand has a flat bottom support so it can't "ride up" on the cylinder. Includes an adjustable 1" (25 mm) wide, 54" (1372 mm) long nylon strap with nickel-plated, non-slip spring catch and buckle for fast, easy adjustment to keep the cylinder safely in place against upper support bar. Lower support bar stops cylinder shift. The PVC coating prevents marring of the cylinder surface. This clamp is not available with a safety message strap.



Description	Dimensions L x W x H	Cylinder Diameter	Item Number
Model 701 PVC Coated Stand	17.25 x 17.25 x 10.75" (438 x 438 x 273 mm)	7 to 10" (178 x 254 mm)	30400017

### Model 703 Stand

This cast aluminum stand hinges open and has 4 thumbscrews to tightly grip cylinders from 8 to 9" (203 to 229 mm) in diameter.

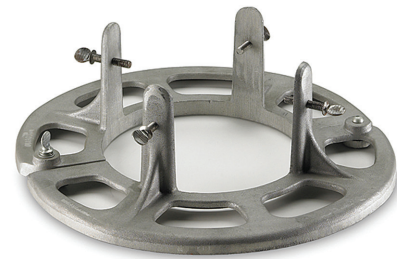

Description	Dimensions (Dia. x H)	Cylinder Diameter	Item Number
Model 703 Stand	18.25 x 6" (464 x 152 mm)	8 to 9" (203 x 229 mm)	30400018

### Model 704 Adjustable Stand

Heavy-duty, cast aluminum stand with adjustable "L" brackets hold cylinders from 6 to 9.25" (152 to 235 mm) in diameter. Hinges open for installation without lifting the cylinder or disturbing connections. Prevents accidental tipping. Hinges open for easy, no-lifting installation.

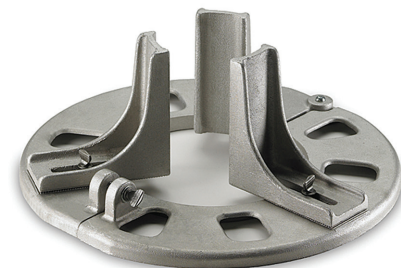

Description	Dimensions (Dia. x H)	Cylinder Diameter	Item Number
Model 704 Adjustable Stand	18.5 x 7.5" (470 x 191 mm)	6 to 9.25" (152 x 235 mm)	30400019

### Model 713 Portable Stand

This cast iron portable cylinder stand offers a sturdy cylinder stand and a convenient cylinder dolly all-in-one. This cylinder stand is designed in two interlocking halves and can be installed without lifting the tank. Built-in rubber wheels for easy mobility. Three thumbscrews tightly grip cylinder.



Description	Dimensions (Dia. x H)	Cylinder Diameter	Item Number
Model 713 Portable Stand	15.5 x 3" (394 x 76 mm)	7 to 9.25" (178 x 235 mm)	30400023

# Flow Control Clamps

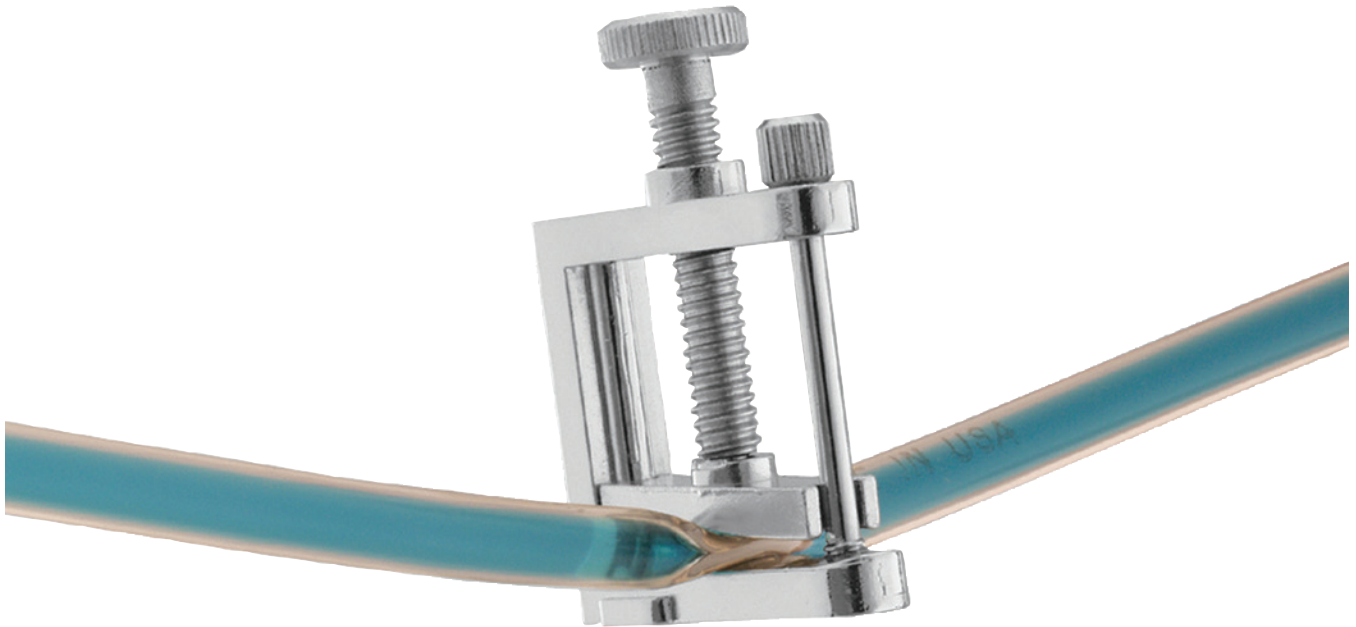

Depend on LabJaws Flow Control Clamps for regulating or interrupting fluid flow. Our Hosecocks feature an adjustment screw with an oversized head which allows for one-hand operation. Pinchcocks are designed to quickly start-and-stop flow with a simple squeeze operation, providing complete closure without damaging the tubing. Select from four hosecock and three pinchcock models designed for a range of applications—from routine to heavy-duty.

- Choose from Four Models of Hosecocks Based on the Diameter of Your Tubing
- Stainless Steel Hosecocks—Ideal for Cleanrooms and Corrosive Environments
- Three Pinchcock Models for Regular to Heavy-Duty Start-and-Stop Flow Operation

# LabJaws Clamps & Supports

## Flow Control Clamps

LabJaws flow control devices offer selection and quality. They are finely machined to deliver accurate regulation or interruption of fluid flow. Every flow control device resists corrosion and rust. Hosecocks offer easy one-hand operation. Convex bearing surfaces and rounded edges protect tubing. Pinchcocks are designed to quickly start and stop flow and provide complete closure without damaging tubing. Operated with a simple squeeze. Nickel-plated construction (unless otherwise noted).

### Regular Hosecock

Adjustment screw with oversized head for accurate regulation. Built-in side lugs for foot mounting. Tubing retainer screw.

#### Stainless Steel

Min. to Max. Grip	Dimensions (W × H - open)	Item Number
0 to 17 mm (0 to 0.67")	37 × 62 mm (1.46 × 2.44")	30392221

#### Nickel-Plated Zinc

Min. to Max. Grip	Dimensions (W × H - open)	Item Number
0 to 17 mm (0 to 0.67")	37 × 62 mm (1.46 × 2.44")	30392210

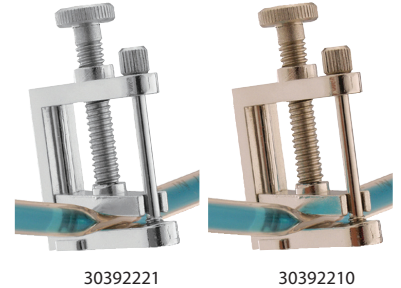

### Heavy-Duty Hosecock

Large hand wheel for ease of flow adjustment. Unique design offers unparalleled control. Works well with heavy cut nylon braided tubing.

Min. to Max. Grip	Dimensions (W × H - open)	Item Number
0 to 29 mm (0 to 1.14")	57 × 106 mm (2.24 × 4.17")	30392310



### Hosecock Extension Clamp

Similar to regular hosecock but with 145 mm (5.7") bottom mounted extension rod for attachment to frames and rods.

Min. to Max. Grip	Arm Length	Arm Dia.	Overall Length	Item Number
0 to 17 mm (0 to 0.67")	145 mm (5.71")	8 mm (0.32")	175 mm (6.89")	30392212

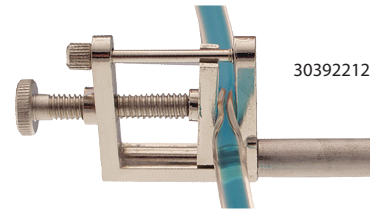

### Hosecock Foot

Add this option to Regular Hosecock (916062 or 916361) for bench or table mounting. Includes two mounting screws.

Diameter	Item Number
27 mm (1.06")	30392211



### Regular Pinchcock

For routine stop/start flow operation.

Min. to Max. Grip	Clamp Height	Item Number
0 to 12 mm (0 to 0.47")	47 mm (1.85")	30392245



### Variable Flow Pinchcock

For precise flow adjustment and duplication of flow rates.

Min. to Max. Grip	Clamp Height	Item Number
0 to 13 mm (0 to 0.51")	47 mm (1.85")	30392247

### Heavy-Duty Pinchcock

Equipped with heavy-duty spring for tough jobs. Ensures complete closure.

Min. to Max. Grip	Clamp Height	Item Number
0 to 11 mm (0 to 0.43")	48 mm (1.89")	30392246



# Misc. Non-Electrical Products



From microbiological colony preparation to histology staining, LabJaws offers a range of products for efficient lab work. Hand-operated, cast iron Inoculating Turntables enable rapid, uniform spreading of bacterial and yeast colonies. Slide Staining Racks designed to fit over a tray or sink are ideal for a variety of histology staining applications. Our product offering also includes AirEjectors which provide rapid air removal within seconds.

- Hand-Operated Inoculating Turntables Enable Smooth Rotation for Spreading Cultures
- Slide Staining Racks Designed to Fit Easily Over a Tray, Dish or Sink
- AirEjector Provides Rapid Air Removal

# LabJaws Clamps & Supports

## Misc. Non-Electrical Products

### Inoculating Turntables

OHAUS hand-operated inoculating turntables produce almost concentric circles of bacterial colonies that are evenly distributed across petri dishes. Cast iron turntables are coated with gray baked acrylic enamel.

The 76 mm (3") high, small turntable accommodates 100 mm petri dishes. It has a tripod base to bring work approximately to eye level. It has a center disk covered with non-skid rubber lining.

The large turntable accommodates 100 mm or 150 mm petri dishes. It has a height of only 32 mm (1.26"), ideal for steadying a forearm on the work surface while plating. The large turntable contains two circular sections. The top section has a raised gripper lip as well as a recessed center disk covered with non-skid rubber lining.

Description	Dimensions (Dia. × H)	Item Number
Small Turntable	4.49 × 3.03" (114 × 77 mm)	30400046
Large Turntable	5.91 × 1.26" (150 × 32 mm)	30400047



### Slide Staining Rack

Constructed of stainless steel, the OHAUS Slide Staining Rack will resist corrosion under normal use. Adjustable to fit trays or sinks up to 533 mm (21") inside.

Description	Dimensions (L × W)	Item Number
Slide Staining Rack	23.74 × 3.5" (603 × 89 mm)	30400048



### Airejector

Rapid air removal evacuates 1 liter of air to 711 mm (28") of vacuum in 30 seconds. Works with compressed air sources to 60 psi. Nickel-plated construction.

Description	Length	Item Number
Airejector	5.51" (140 mm)	30392367









## OHAUS Corporation

Headquartered in Parsippany, NJ, OHAUS Corporation manufactures an extensive line of high-precision electronic and mechanical balances and scales that meet the weighing needs of virtually every industry. We are a global leader in the laboratory, industrial, and education channels as well as a host of specialty markets, including the food preparation, pharmacy and jewelry industries. An ISO 9001:2008 manufacturer, OHAUS products are precise, reliable and affordable, and are backed by industry-leading customer support. For additional information, contact OHAUS Corporation at 1.973.377.9000, or visit [www.ohaus.com](http://www.ohaus.com).

**OHAUS CORPORATION**  
\* 7 Campus Drive  
Suite 310  
Parsippany, NJ 07054 USA

Tel: 800.672.7722  
973.377.9000  
Fax: 973.944.7177

[www.ohaus.com](http://www.ohaus.com)

*With offices throughout  
Europe, Asia, and  
Latin America*

**\*ISO 9001:2008**  
Registered Quality  
Management System

*Ingeniously Practical*