

102DH

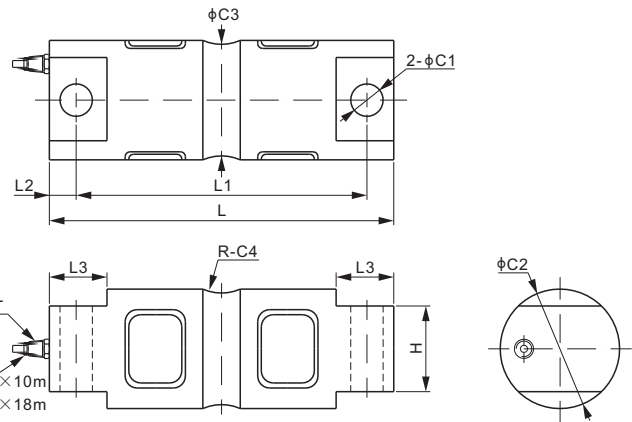

Alloy Steel



Capacity ≤ 30Klb Cable φ5.1×10m
Capacity ≥ 30Klb Cable φ7.6×18m

DIMENSIONS

RATED CAPACITY	C1	C2	C3	C4	H	L	L1	L2	L3	T
Klb/inches										
5-20	0.66	1.95	1.48	0.50	1.12	8.12	6.87	0.62	1.44	1/4-18 NPT
30-75	1.06	3.00	2.73	1.00	2.37	10.25	8.50	0.88	1.88	1/2-14 NPT
100	1.06	3.50	3.24	1.50	2.50	11.25	9.50	0.88	1.88	1/2-14 NPT
150	1.06	3.90	3.64	1.50	2.80	11.25	9.50	0.88	1.88	1/2-14 NPT
200	1.56	5.38	5.17	2.00	4.60	16.10	13.0	1.55	3.05	1/2-14 NPT
kg/mm (conversion of above dimensions)										
2,268-9,071.8	16.7	49.5	37.6	12.7	28.4	206.2	174.6	15.8	36.6	1/4-18 NPT
13,607.7-34,019.4	26.9	76.2	69.3	25.4	60.2	260.4	215.9	22.3	47.8	1/2-14 NPT
45,359.2	26.9	88.9	82.3	38.1	63.5	285.8	241.3	22.3	47.8	1/2-14 NPT
68,038.9	26.9	99.1	92.5	38.1	71.1	285.8	241.3	22.3	47.8	1/2-14 NPT
90,718.5	39.6	136.7	131.3	50.8	116.8	408.9	330.2	39.4	77.5	1/2-14 NPT

SPECIFICATIONS

Full Scale Output	3.0 mV/V ± 0.25%	Recommended Excitation	10V (15V Maximum)
Zero Balance	± 0.02 mV/V	Insulation Resistance	>2 [50V DC] GΩ
Non-linearity	< ± 0.023%	Compensated Temperature Range	-10°C to 50°C / 14°F to 122°F
Repeatability	< ± 0.017%	Safe Overload	150% of full scale
Hysteresis Error	< ± 0.023%	Breaking Overload	300% of full scale
Creep in 30 min.	< ± 0.023%	Seal Type / IP Rating	Environmentally Sealed / IP67
Input Resistance	700Ω ± 10	Cable Color Code	Exc+ Red Exc- Black
Output Resistance	700Ω ± 5		Sig+ Green Sig- White
Element Material	Alloy Steel, Nickel Plated		Shield Bare

PART NUMBER

Rated Capacity	Part No.	Weight (kg) Approx.
5Klb	102DH-5Klb	2.4
10Klb	102DH-10Klb	2.7
15Klb	102DH-15Klb	2.7
20Klb	102DH-20Klb	2.7
30Klb	102DH-30Klb	9.0
40Klb	102DH-40Klb	9.0
50Klb	102DH-50Klb	9.0
60Klb	102DH-60Klb	9.0
75Klb	102DH-75Klb	9.0
100Klb	102DH-100Klb	12.1
150Klb	102DH-150Klb	18.3
200Klb	102DH-200Klb	38.0

WEIGH MODULE

Model	Page
102DHM3	127

INTERCHANGEABLE PRODUCTS

Manufacturer	Model
Coti Global	CG-5103
Rice Lake	RL70000
Vishay Revere Transducers	5103
Vishay Sensortronics	60058



20Klb-120Klb: NTEP 1:10 000 Class III L, Multiple Cell



9t-45t: OIML MAA C4, Y=15 000